



PROFESSIONAL SHOW LIGHTING

# MINISCAN

 HMD 300  
 HTI 300  
 HTI 150

## INSTRUCTION MANUAL

**IMPORTANT:** Read carefully. It is essential for the correct and safe use of the equipment that erectors and operators should be fully conversant with the information and instructions given in this manual.

### 1 INSTALLING THE PROJECTOR

#### • Unpacking

Open the box, remove the projector from the packing and place it on a flat horizontal surface. Unpack the standard accessories supplied with the equipment. Inspect the lamp change label (1) and replace with one of the optional language versions if necessary.

**Make certain that the label is never removed, as it displays important safety information.**

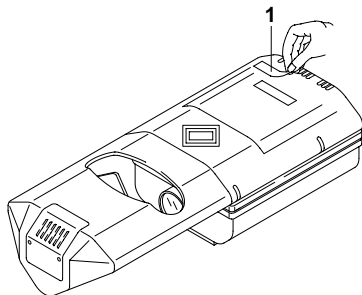

#### • Initial assembly operations

Position the bracket (2) the desired height and secure by tightening the knobs (3). The bracket can also be fitted from the underside of the projector.

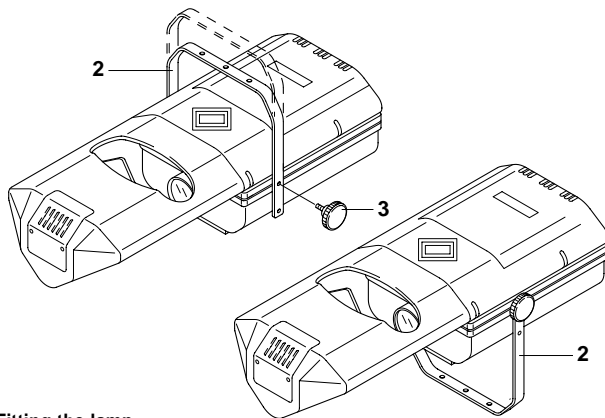

#### • Fitting the lamp

Refer to directions for replacement of the lamp given under heading 6 MAINTENANCE.

#### • Installing the projector

The projector can be mounted in any position without its operating characteristics being affected.

**IMPORTANT:** fix the projector in the desired position utilizing the holes in the bracket (2). Secure preferably using two  $\phi 10$  bolts with nuts and lock washers.

**Make certain that the anchorage is stable before positioning the projector.**

#### • Minimum distance from target objects

The projector must be positioned in such a way that objects struck by the beam are separated from the lens at least by the distance indicated on the lamp change label next to the symbol illustrated alongside.

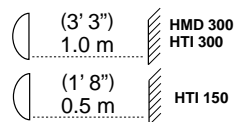

• Minimum distance of inflammable materials from any part of the equipment: 0.10 m (4").

**F** The appliance may be mounted on surfaces rated normally inflammable.

**IMPORTANT:** For better and more reliable operation of the projector, the ambient temperature must not exceed 35° C (95° F). Protection factor IP 20: the appliance is protected against penetration of solid bodies more than 12mm (0.5") in diameter (first digit 2), but can be damaged by spray, jet, drip or rain water (second digit 0).

### 2 POWER SUPPLY AND INTERFACE

#### • Connecting to the electrical power supply

The operations described in this heading must be carried out by a licensed electrician.

The projector must be wired up to the electrical power supply using the special socket connector provided. It is good policy to connect projectors to the power supply by way of dedicated switches, so that each can be turned on and off individually from a remote station.

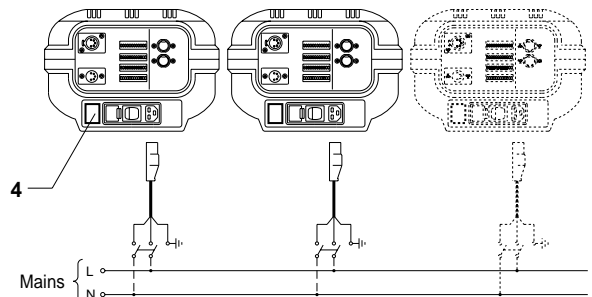

The projector is designed to operate at the voltage and frequency indicated on the electrical data plate (4) affixed to the rear end. Check that these two values correspond to the mains voltage and frequency.

**IMPORTANT:** the projector must be connected to a power supply circuit having a proper earth system (Class I appliance).

#### • Connecting the control signals

##### 0-10V CONNECTION

- Projectors operating independently of one another

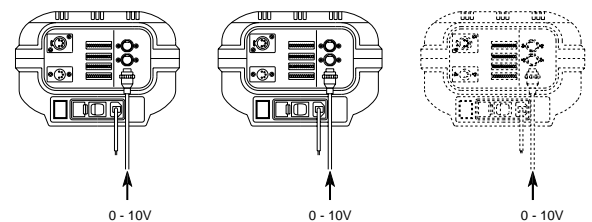

- Projectors operating simultaneously and identically

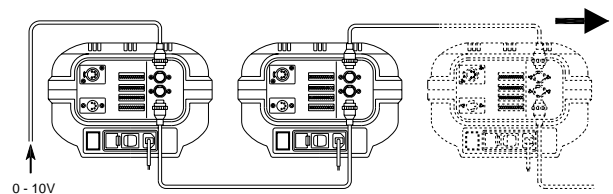

The connection between controller and projector must be made using a multicore cable with 8 wires of 0.25mm<sup>2</sup> section and a DIN 8 PIN 45° plug/socket connector.

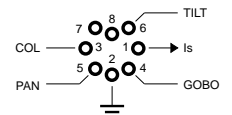

##### RS 232/423(PMX) - DMX 512 CONNECTION

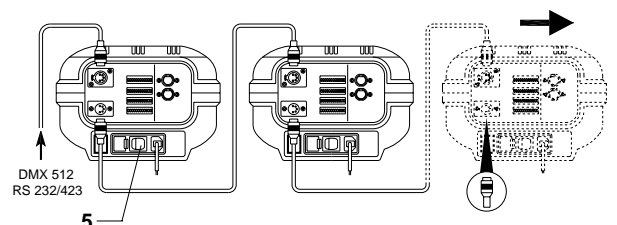

Projectors are wired up to the controller and one to the next using two-core screened cable and Cannon 5 pin XLR type plug/socket connectors.

To connect a DMX line, a terminating plug (7) with a 100Ω resistor wired between pins 2 and 3 must be fitted to the last projector connected in series; the plug is not required when using a RS232/423(PMX) signal.

**The wires must not come into contact with each other or with the metal casing of the plug.**

**The casing of the plug/socket must be connected to the screen and to pin 1 of the connectors.**

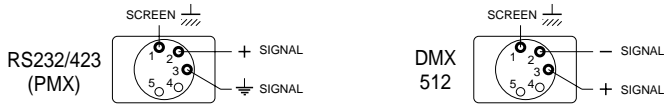

Having completed the operations described above, press the on/off switch (5). Check that the warning light comes on and that the auto-reset sequence starts.

**• Projector address codes (for digital signals)**

A single MINISCAN utilizes 4 control channels. To ensure that the different projectors are addressed correctly by the controller, a code must be assigned to each one. The operation is carried out on each MINISCAN by setting the dip-switches as indicated in the table below.

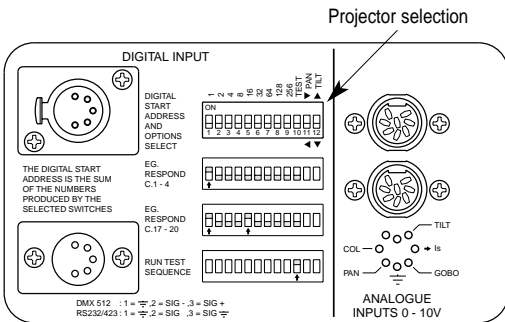

CODE	1	2	4	8	16	32	64	128	256	TEST
Projector 1 - Channels 1-4	ON	▲	▼	▼	▼	▼	▼	▼	▼	▼
Projector 2 - Channels 5-8	ON	▲	▲	▼	▼	▼	▼	▼	▼	▼
Projector 3 - Channels 9-12	ON	▲	▼	▲	▼	▼	▼	▼	▼	▼
Projector 4 - Channels 13-16	ON	▲	▲	▲	▼	▼	▼	▼	▼	▼
Projector 5 - Channels 17-20	ON	▲	▼	▼	▲	▼	▼	▼	▼	▼
Projector 6 - Channels 21-24	ON	▲	▼	▲	▼	▼	▼	▼	▼	▼
Projector 7 - Channels 25-28	ON	▲	▼	▼	▲	▼	▼	▼	▼	▼
Projector 8 - Channels 29-32	ON	▲	▼	▲	▼	▼	▼	▼	▼	▼
Projector 9 - Channels 33-36	ON	▲	▼	▼	▲	▼	▼	▼	▼	▼
Projector 10 - Channels 37-40	ON	▲	▼	▼	▼	▲	▼	▼	▼	▼
	ON	▲	▼	▼	▼	▼	▼	▼	▼	▼
	OFF	▼	▲	▲	▲	▲	▲	▲	▲	▲

Setting the TEST switch to the ON position for a few seconds with the projector powered-up, an auto-reset routine is carried out. Leaving the TEST switch at the ON position for a longer period, a full self-test program will be completed; once the operation has terminated, return the switch to the OFF position.

**3 POSITIONING THE PROJECTOR**

Before positioning the projector, set the channels as shown in the following table:

CHANNEL	POSITION OF SLIDER
1 COLOUR WHEEL	0% (white beam)
2 GOBO CHANGE/DIMMER/STOPPER/STROBE	100% (white beam)
3 PAN	50% (Central position)
4 TILT	50% (Central position)

**• Aligning the beam**

Having completed all the operations indicated thus far, loosen the knobs (3), manoeuvre the projector on the bracket (2) until the beam is directed at centre stage, then retighten the knobs (3).

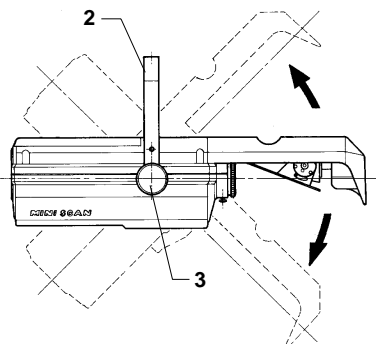

**• Adjusting the lens**

Move the lens (6) back and forward until the projected image is satisfactorily focused, then tighten the knob (7).

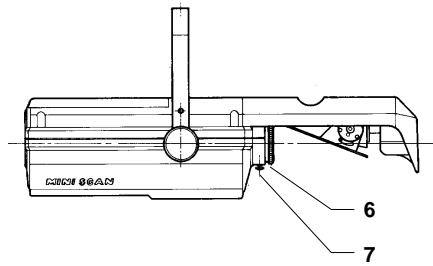

**4 CHANNEL FUNCTIONS AND OPTIONS**

CHANNEL	FUNCTION
1	COLOUR WHEEL
2	GOBO CHANGE/DIMMER/STOPPER/STROBE
3	PAN
4	TILT

Select the options by setting the dip-switches as indicated.

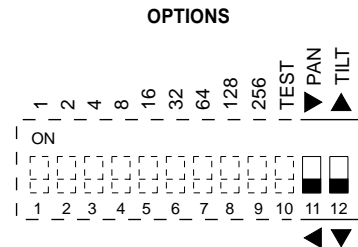

**• COLOUR WHEEL - channel 1**

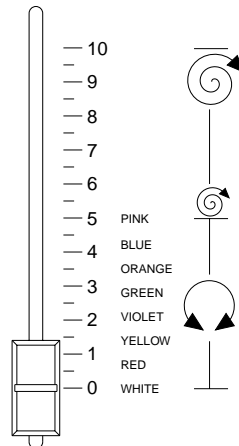

In the 0% to 50% range of adjustment, the change of colour in response to the movement of the potentiometer is linear and continuous, so that the slider can be stopped in intermediate positions to obtain a two colour beam. From 50% to 100% the wheel rotates continuously with speed increasing steadily from 0 to 300 rpm.

**• GOBO ROTATION /OSCURATORE/STOP/STROBO - channel 2**

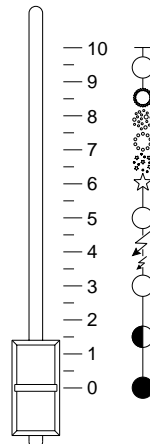

In the 0% to 30% range of adjustment, the dimmer opens gradually to maximum aperture. Strobe effect is produced from 30% to 49.7%, with frequency increasing from 1 to 7 flashes per second. At 50% the aperture is fixed. The gobo sequence is produced between 60% and 85% of the slider travel, as indicated in the diagram. The aperture remains fixed between 85% and 100% of the range.

• PAN - channel 3

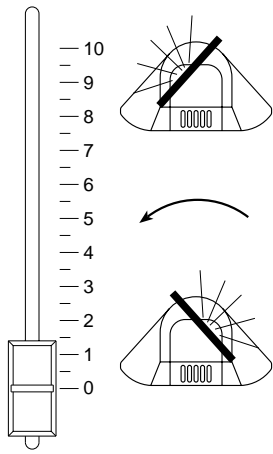

**Standard operation**

Horizontal movement (Pan) of the mirror is linear and continuous in response to the movement of the slider, occurring gradually and uniformly between 0 and 10 on the scale.

The mirror can be stopped at any angle within the range of adjustment.

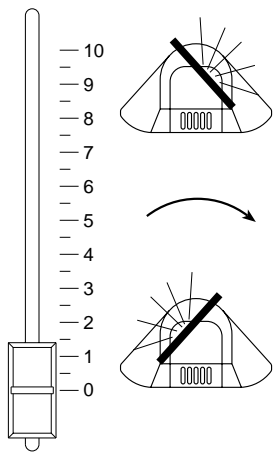

**Optional operation**

The starting position and the direction of movement can be reversed. The panning movement of the mirror is produced in exactly the same way (see previous paragraph).

• TILT - channel 4

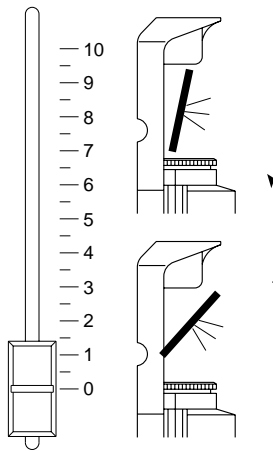

**Standard operation**

Vertical movement (Tilt) of the mirror is linear and continuous in response to the movement of the slider, occurring gradually and uniformly between 0 and 10 on the scale.

The mirror can be stopped at any angle within the range of adjustment.

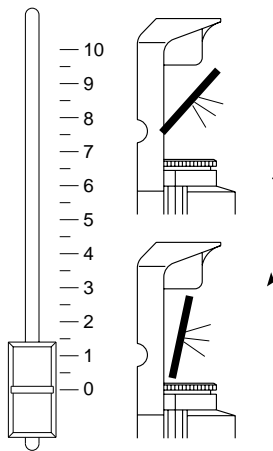

**Optional operation**

The starting position and the direction of movement can be reversed. The tilting movement of the mirror is produced in exactly the same way (see previous paragraph).

5

LENS UNITS

GRAPHS SHOWING BEAM DATA AND ILLUMINATION VALUES

**Objective 1:2,5/165mm - Standard equipment**

<b>Miniscan 300 (HMD)</b>	(lux)	1980	495	220	124
	(fc)	184	46	20,4	11,5
<b>Miniscan 300 (HTI)</b>	(lux)	2610	650	290	165
	(fc)	242	60,4	26,9	15,3
<b>Miniscan 150 (HTI)</b>	(lux)	1400	370	161	90
	(fc)	130	34,4	15	8,36

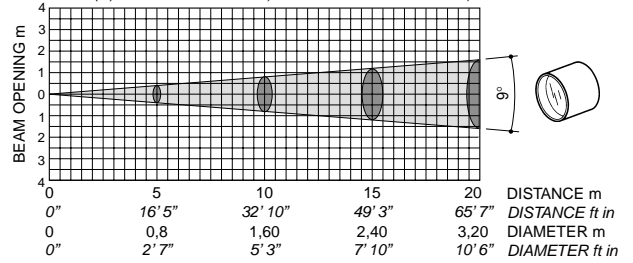

**Objective 1:2,2/100mm - Available on request**

<b>Miniscan 300 (HMD)</b>	(lux)	780	195	87	49
	(fc)	72,5	18,1	8,08	4,55
<b>Miniscan 300 (HTI)</b>	(lux)	1000	250	111	62
	(fc)	92,9	23,2	10,3	5,76
<b>Miniscan 150 (HTI)</b>	(lux)	500	125	55	32
	(fc)	46,5	11,6	5,11	2,97

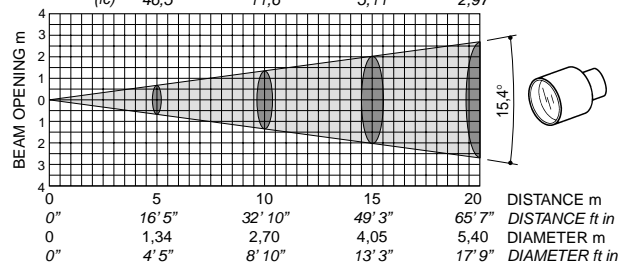

6

MAINTENANCE

**IMPORTANT:** isolate the projector from the electrical power supply before commencing maintenance work of any description..

The maximum temperature on the outer surface of the projector under normal operating conditions is 100°C (212° F). After switching off, do not remove any part of the projector for at least 10 minutes, as indicated on the lamp change label (1). Once this time has elapsed, the risk of a lamp exploding is practically zero. If the lamp needs changing, wait a further 15 minutes to avoid the risk of burns. In the event of a lamp exploding, the appliance is designed to prevent fragments of glass from being scattered. Lenses and clear filters supplied with the appliance must be fitted at all times, and if visibly damaged must be replaced promptly with genuine spares.

• Opening the projector

Remove the lamp access cover (8) from the projector by pushing in the direction arrowed. Once the necessary work has been completed, refit the cover (8).

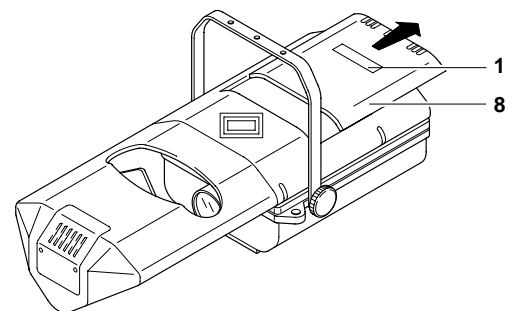

• Changing the lamp (MINISCAN 150)

Remove the lamp (9) from its fitting (10), withdrawing in the vertical direction. Locate the new lamp in the fitting, ensuring that the pins are positioned correctly.

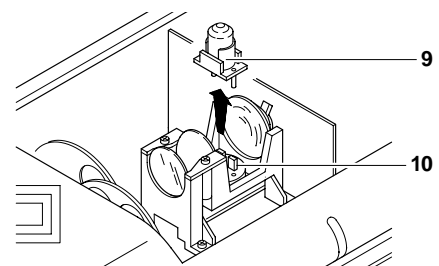

### • Changing the lamp (MINISCAN 300)

Open the projector, loosen the two side nuts (11) of the lamp to be changed and remove it from the supports (12).

Remove the new lamp from its packaging, loosen the two side nuts (11) and locate the lamp in the supports (12). Finally, retighten the nuts.

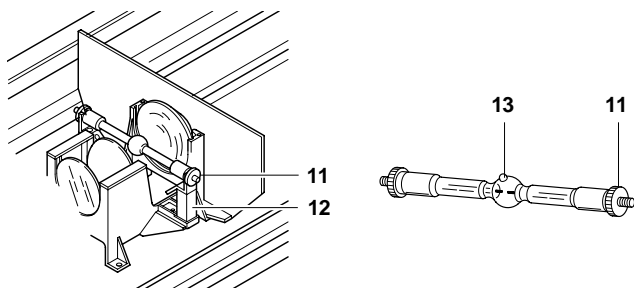

**IMPORTANT:** for uniform distribution of the light beam, the lamp must be positioned so that the glass pip (13), on the bulb does not coincide with the optical axis of the projector. With this in mind, locate the pip as high up as possible.

**CAUTION:** The projector uses a high pressure discharge lamp with external starter.

### CAUTION:

- When fitting a new lamp, read the manufacturer's instructions carefully.
- The lamp must always be changed without delay if damaged or deformed by heat.

### • Replacing fuses

To change the fuses, press the tab (14) and pull out the fuse holder (15). Replace any blown fuse with one of the same type and rating as indicated on the label (16) attached to the holder (15). Insert the fuse holder and push in to engage the tab (14).

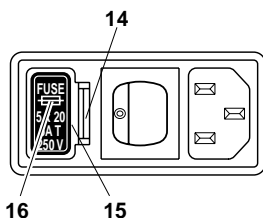

### • Routine cleaning

To maintain the light output of the projector undiminished, parts that tend to accumulate dust and grease must be cleaned periodically. In most circumstances, the projector will give long and trouble-free service if these simple guidelines are followed. To remove dirt from the lenses and filters, use a soft cloth moistened with any liquid detergent suitable for cleaning glass.

**IMPORTANT:** do not use solvents or alcohol

- Parts that need cleaning frequently.
- Parts that need cleaning monthly.

Internal components should also be given a general clean once a year, dislodging dust and dirt with a brush and removing it simultaneously with a vacuum cleaner.

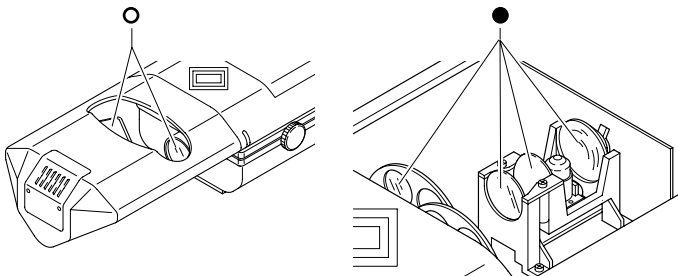

## 7 TROUBLESHOOTING

PROJECTOR DOES NOT LIGHT UP			FAULT
ELECTRONICS NOT WORKING			
PROJECTION FAULTY FAULTS			
REDUCED BRIGHTNESS			
		POSSIBLE CAUSES	CHECKS AND REMEDIES
●		No electrical power supply.	Check that power is available at the mains socket and/or that fuses are intact.
●	●	Lamp expended or faulty.	Change lamp (see instructions).
	●	Signal transmission cable short-circuiting or disconnected.	Change cables.
	●	Address codes incorrect.	See projector coding instructions.
	●	Defect in electronic circuits.	Contact an authorized technician.
	●	Lenses broken.	Contact an authorized technician.
	● ●	Deposit of dust or grease.	Clean (see instructions).

## 8 TECHNICAL DATA

### ELECTRICAL/MECHANICAL SPECIFICATION

#### Power supply

##### MINISCAN

- 220 - 240V 50Hz
- 200V 50Hz - 230V 60Hz
- 200V 60Hz

##### MINISCAN 300

Metal iodide type with special built-in power supply unit.

- Type HMD 300W
  - Cap SFc 10-4
  - Colour temperature 5000 K
  - Luminous flux 18000 lm
  - Average life 3000 h
- Type HTI 300W
  - Cap SFc 10-4
  - Colour temperature 6500 K
  - Luminous flux 22000 lm
  - Average life 750 h

##### MINISCAN 150

Metal iodide type with special built-in power supply unit.

- Type HTI 150W
  - Cap GY 9.5
  - Colour temperature 6900 K
  - Luminous flux 9500 lm
  - Average life 750 h

#### Power consumption

- MINISCAN 300: 800VA at 220V 50Hz
- MINISCAN 150: 500VA at 230V 50Hz

#### Motors

N. 4 microstepping motors with full micro-processor control.

### OPTICAL SYSTEM

#### Optical unit

Main optical unit in diecast aluminium, incorporating twin lens condenser and a reflector of high luminous efficiency.

#### Lens units

- Standard: 1:2,5/165 mm (9°).
- Optional: 1:2,2/100 mm (15°20').

#### MIRROR HEAD

Mirror of ultra high luminous efficiency.

#### Movement

- Produced by two controlled microstepping motors.
- Infinitely variable speed of rotation; maximum values:
  - horizontal (PAN) = 0.4 sec (150°)
  - vertical (TILT) = 0.3 sec (110°)
- Continuous and uniform movement.
- Resolution:
  - PAN = ±0.3° (150°)
  - TILT = ±0.2° (110°)

### CONTROL SYSTEMS

#### Channels

N. 4 control channels.

#### Inputs

The MINISCAN is set up to accept analog or digital signals from controllers or computers.

- Digital serial input: RS232/423(PMX) or DMX 512
- Analog input 0-10V

### GENERAL CHARACTERISTICS

#### Safety devices

- Power supply shuts off automatically in the event of overheating or cooling system failure.
- Power shuts off automatically when cover is opened (MINISCAN 300 only).

#### Cooling

Forced ventilation cooling system using axial flow fans.

#### Housing

- Extruded die-cast aluminium..
- Epoxy powder coated finish.

#### Mounting

- Steel bracket with epoxy powder coated finish.
- Two installation positions, 50 mm (2") apart.
- Bracket adjustable through 110°.

#### Operating position

Will function in any position.

#### Weights and dimensions

- MINISCAN 300: 10.5 kg. (23 lbs 2 ozs)
- MINISCAN 150: 8.5 kg. (18 lbs 11 ozs)

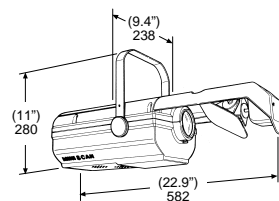

MINISCAN 300

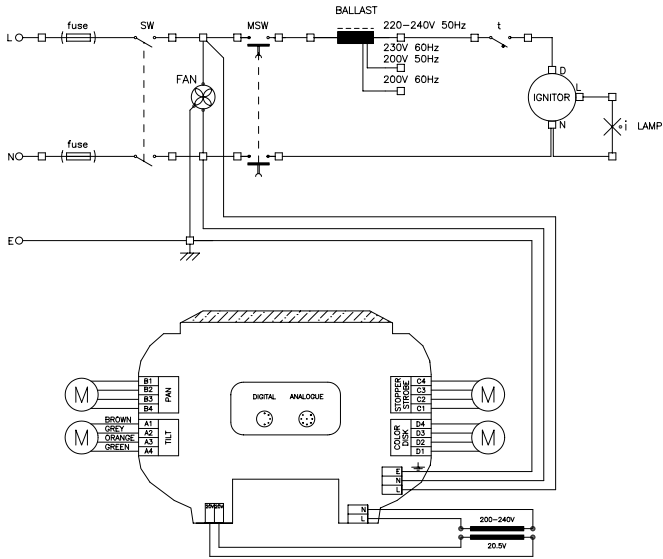

MINISCAN 150

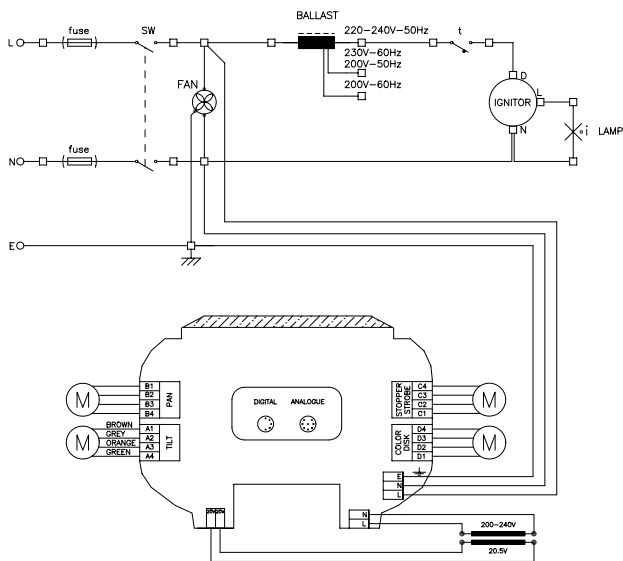

The specifications published in this manual are not binding, and may be revised or updated at any time by Clay Paky without notice in the interests of improving product quality.



The products referred to in this manual comply with EC Directives on:

- Low Voltage 73/23
- Electromagnetic Compatibility 89/336